

Article number: 2310431046S

Description: E+G Levelling elements  
LX.40-SW17-M10X72-S

## Measures

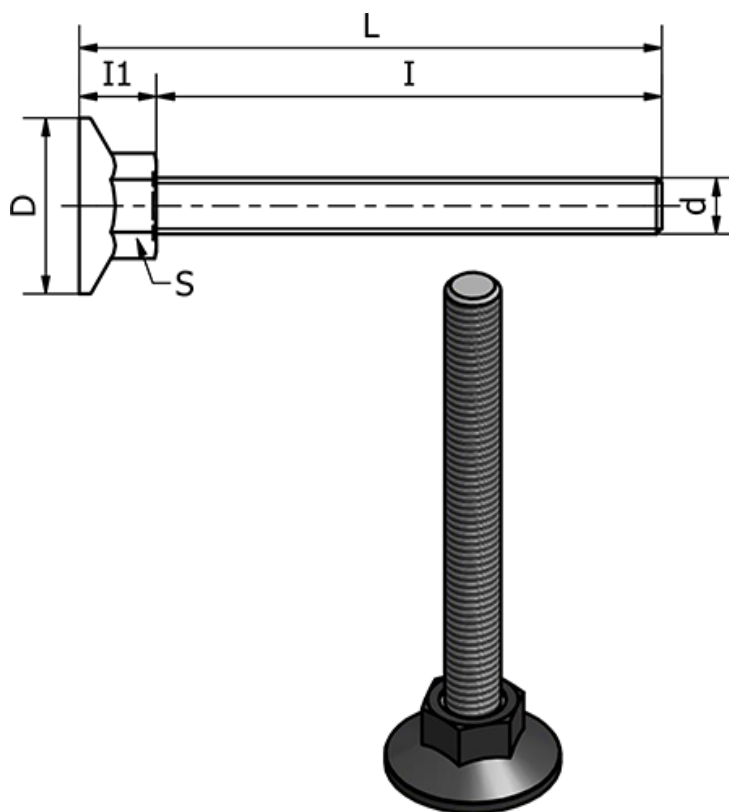

d	= M10
D	= 40
I	= 72
I1	= 13
L	= 84.5
S	= 17
Static load in (N)	= 3000
Type	= Forzinket

Weight (g) = -